

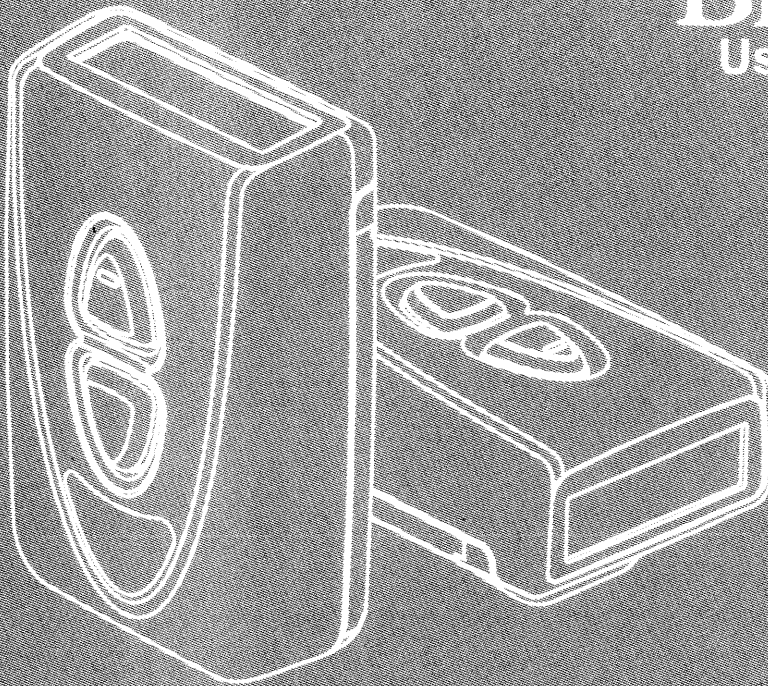

Br502

User Manual



| | | | |
|--------------------------------|-----------|---------------------------------|-----------|
| Contents | 1 | Setting the Alarm | 12 |
| Introduction | 2 | Setting the Time | 13 |
| Effective Use of Your Pager .. | 2 | Setting the Date | 14 |
| Features | 3 | Setting Reminder Alert | 15 |
| Getting Started | 4 | Setting Low Battery Alert | 16 |
| Battery Information | 4 | Setting Message Information .. | 17 |
| Installing/Replacing | | Setting Private Time | 18 |
| the Battery | 5 | Messages | 19 |
| Control Buttons | 6 | Reading Messages..... | 19 |
| Turning Your Pager On | 7 | Protecting/Unprotecting | |
| Turning Your Pager Off | 7 | Messages | 20 |
| Backlight | 8 | Deleting Messages | 21 |
| Using the Function Menu..... | 8 | Deleting Individual Messages . | 21 |
| Status Indicators | 9 | | |
| Function Menu | 10 | | |
| Setting the Alert Type | 10 | | |
| Deleting All Messages | 11 | | |

INTRODUCTION

Congratulations on the purchase of your Br502 FLEX™ Numeric pager. This booklet contains operation instructions that explain how to use your new pager and provides helpful suggestions for first-time as well as experienced users.

Effective Use of Your Pager

The Br502 FLEX pager keeps you in close contact with business associates, family, and friends. This new generation of pagers enables on-the-go professionals to stay connected wherever business or life takes them.

Features

- Up to 18 personal memory slots
- Protects up to 10 messages
- Individual message delete or delete all
- Backlight
- Private time
- Daily alarm
- Time and date display
- Time and date message stamping
- Alert types: Melody, Chirp, Vibration, Vibration-chirp, Silent
- Battery level indicator
- Battery low indicator and alert
- Unread message reminder alert
- Duplicate message indication
- Continuous message indication
- Error message indication
- Memory full indication
- Memory retention for 30 seconds during battery change
- Removable belt clip

GETTING STARTED

Battery Information

Your pager is powered by a single AAA-size alkaline battery. Do not use any other battery type other than AAA alkaline.

When the battery is low, the pager will emit a low battery alert and the battery icon will flash. While the pager does have a lithium power source to protect data stored in memory, you should replace the battery immediately.

If the battery is not replaced the pager will shut down because the device cannot support normal operation. Messages and settings will be lost if the battery is not replaced immediately. However, protected messages will be saved.



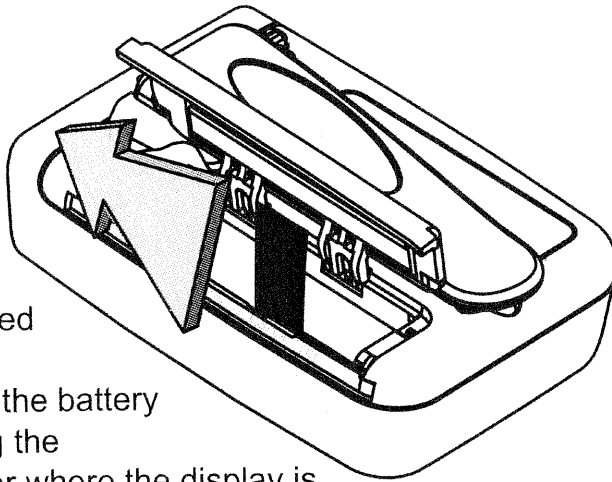

WARNING - Use of a battery other than an Energizer E92 OR a Duracell MN2400, 1.5V AAA Alkaline Battery may affect the Intrinsic Safety UL rating of the device.

Installing/Replacing the Battery

- Turn your pager off (see "Turning Your Pager Off" on page 7)
 - Hold the pager face down.
- Open the battery compartment by pressing down with your thumb on the battery door and sliding the battery door in the direction indicated by the arrow on the battery door
- Lift up the battery door to access the battery
 - Remove the old battery by pulling the ribbon towards the end of the pager where the display is (see illustration)
 - Insert a new battery so the polarity markings on the battery match the polarity diagram on the housing
 - Turn on the pager(see "Turning Your Pager On" on page 7). If the pager does not turn on, then check to make certain the battery has been inserted correctly, or try another new battery



Control Buttons

-  **READ/SELECT Button:**
Press to read messages, select a feature or move from one field to another.
-  **FUNCTION Button:**
Press to enter the function menu, scroll through the function menu or change the value of a field, hold for two seconds to turn on or off backlight.
-  +  **Button COMBINATION:**
Press the Read/Select and the Function button simultaneously to escape back to the Status screen from the message or function screens.

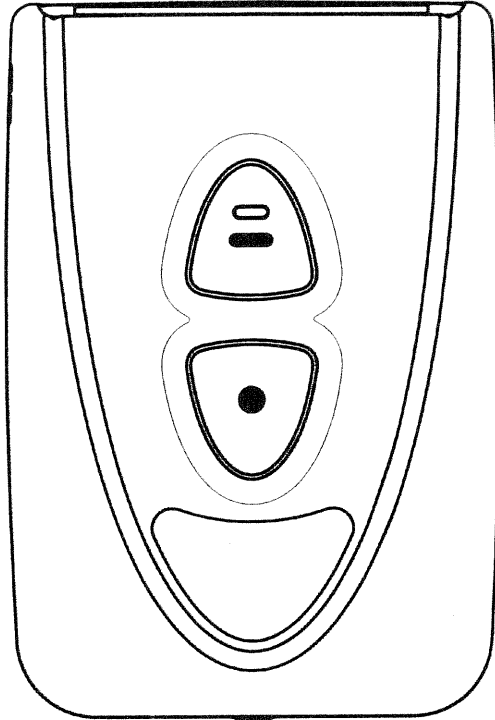

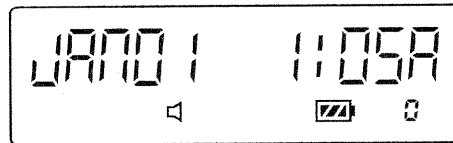

Turning Your Pager On

- Make sure that a new battery is properly installed as discussed in the "Installing/ Replacing the Battery" section on page 5
- Press and hold down the  (Read/Select) button for 2 seconds to turn your pager on. The Status screen displays
- When the pager is on and no activity is taking place, the Status screen displays date, time and other relevant status indicators



Turning Your Pager Off

- Press the  (Function) button 3 times until "PAGE OFF" displays, then press the  (Read/Select) button and the pager will turn off
- Note that the screen will display the word "OFF" and the time.
- To turn your pager back on follow step 2 of Turning Your Pager On (above)

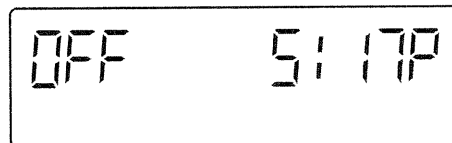



Backlight

In low-light conditions, you can turn the pager's backlight on or off at any time (even when the pager is turned off). Press and hold down the  (Function) button for two seconds. You may repeat this step to manually turn off the backlight, or after 15 seconds of inactivity, the backlight automatically turns off when the pager returns to the Status screen.





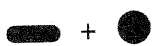







Using the Function Menu

The function menu provides access to the many of your pager features through the use of symbols and prompts.



-  (Read/ Select) button to select the displayed feature,
-  (Function) button to navigate through the function menu,
-  (Read/Select + Function button combination) any time to return to the Status screen.

Status Indicators

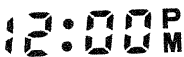
The list below explains each of the Status Indicators that may display on your pager.

- | | |
|--|--|
|  - New/Unread Message |  - Duplicate Message |
|  - Audio Alert |  - Private Time |
|  - Silent Alert |  - Battery Level |
|  - Vibe Alert |  - Low Battery (blinking icon) |
|  - Vibe-Chirp Alert |  - Total Messages (Status Screen) and Message Number (Message Screen) |
|  - Alarm |  - Continuous Message |
|  - Locked Message |  - Message Time Stamp |

FUNCTION MENU





If at any time you wish to quit from any function menu screen there are two methods for escaping; 1) Press both  +  (Read/Select + Function) simultaneously, 2) Wait for 15 seconds. In both cases the display is returned to the Status screen.

Setting the Alert Type

Your Br502 pager has both audible and silent alert types. These alert types are:



- Vibe (vibrate)
- Silent (no alert)
- Vibe-chirp (vibrate then chirp)
- Chirp
- Eight melody alerts

To specify the alert to play when your pager receives a message, proceed as follows:

- From the Status screen, press the  (Function) button once until "SET ALERT" displays then press the  (Read/ Select) button. The current alert setting will display
- Press the  (Function) button to begin scrolling through the alert types. A sample of the displayed alert type will be played
- When the desired alert type displays, press the  (Read/ Select) button to select it and return to the Status screen

Deleting All Messages

This feature allows you to delete all unlocked messages at once.

- From the Status screen, press the  (Function) button 2 times until "DELETE ALL" displays, and then press the  (Read/ Select) button
- When "DELETE ALL" displays, press the  (Read/ Select) button to confirm your decision
- To delete individual messages see the instructions on page 21

Setting the Alarm

Your Br502 pager allows you to set a daily alarm.

- From the Status screen, press the ● (Function) button 4 times until the " SET ALARM " screen displays

- A flashing " ON " or " OFF " appears, toggle the ● (Function) button to select ON or OFF. Press the ■ (Read/ Select) button to confirm your selection

Note: If you select OFF the pager will return to the Status screen. If you select ON proceed to the next step

- Press the ■ (Read/ Select) button to select the hour, then press the ● (Function) button to set the hour

- Repeat the above steps to set minutes and " A " or " P ", if your pager is set to display 12 hour time format

- When complete, press the ■ (Read/Select) button to save your changes and return to the Status Screen

Setting the Time

- From the Status screen, press the ● (Function) button 5 times until " SET TIME " displays, then press the ■ (Read/ Select) button.

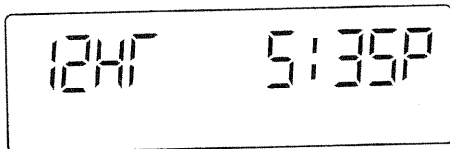

- Press the ● (Function) button to select 12 or 24 hour time. When the desired setting displays, press the ■ (Read/ Select) button to advance to the next field

- Press the ● (Function) button to increase the hour. When the desired hour displays, press the ■ (Read/ Select) button to advance to the next field

- Repeat Step 3 to set the "minutes" and "A" or "P", if set to 12 hour time format

- When you have finished setting the time, the ■ (Read/ Select) button will return you to the Status screen

Setting the Date

- From the Status screen, press the ● (Function) button 6 times until "SET DATE" displays, and then press the ■ (Read/ Select) button

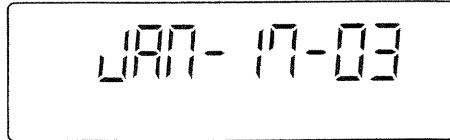

- Press the ● (Function) button to advance the month. When the desired month displays, press the ■ (Read/ Select) button
- Repeat step 2 (above) to set the day and year
- When you have finished setting the time, press the ■ (Read/ Select) button to save your changes and return to the Status screen

Setting Reminder Alert

This feature allows you to turn ON/OFF reminder alerts. Reminder alerts repeat at two-minute intervals until you have read all new messages. To turn ON/OFF reminder alerts, proceed as follows:

- From the Status screen, press the ● (Function) button 7 times until "REM ALERT" displays, then press the ■ (Read/ Select) button to display "REM ALT" and a flashing "ON" or "OFF"
- Press the ● (Function) button to toggle between "ON" and "OFF"
- Press the ■ (Read/Select) button to make your selection and return to the Status screen

Setting Low Battery Alert

This feature allows you to turn on and off the Alert that sounds when the battery is running low. The alert will sound every hour between 8am and 8pm when this feature is on.

- From the status screen, press ● (Function) button 8 times until "BATT ALERT" displays, and then press ■ (Read/Select) button to display " BATT ALT " and flashing " ON " or " OFF "
- Press the ● (Function) button to toggle between " ON " and " OFF ", and press ■ (Read/Select) button to make your selection and return to the Status screen

Setting Message Information

This feature allows you to turn on and off the message information that comes with a message. This information can include source indication, message type (personal or group message) and date stamping.

- From the status screen, press ● (Function) button nine times until "MESSAGE INFO" displays. Then press the ■ (Read/Select) button to display " INFO " and a flashing " ON " or " OFF "
- Press the ● (Function) button to toggle between " ON " and " OFF ", and press ■ (Read/Select) button to make your selection and return to the Status screen

Setting Private Time

You can set your pager to Private Time. During this time the pager will still receive messages as usual but it will not alert.

- From the Status screen, press the ● (Function) button 10 times until "PRIVATE TIME" displays, and then press the ■ (Read/ Select) button
- The display shows "PTI TIME" with a flashing "ON" or "OFF", toggle the ● (Function) button to select ON or OFF. Press the ■ (Read/ Select) button to confirm your selection

Note: If you select OFF the pager will return to the Status screen. If you select ON proceed to the next step.

- To set pager START time scroll through hours by pressing the ● (Function) button for each hour increment, then press the ■ (Read/ Select) button to set and advance to the minutes. Repeat this step to set minutes and "A" or "P", if your pager is set to display 12 hour time format
- Press the ■ (Read/ Select) button to set the END time by repeating the above steps
- When complete, press the ■ (Read/Escape) button to return to the Status screen

MESSAGES

The pager can store up to 18 personal messages. If you have programmed your pager to alert you when it receives a message, an alert sounds (see "Setting the Alert Type" on page 10).

Reading Messages

- From the Status screen press the ■ (Read/ Select) button to read your messages
- Continue pressing the ■ (Read/ Select) button to scroll through your messages
- If your pager receives a message that contains errors, the character with errors will blink
- Messages that are not "protected" will be lost when the pager's memory is full. It is recommended that you delete unwanted messages frequently to avoid message loss. (See page 20, Protecting/Unprotecting Messages.)

If at any time you wish to quit from the message screen there are two methods for escaping; 1) Press both ■ + ● (Read/Select + Function) simultaneously, 2) Wait for 15 seconds. In both cases the display is returned to the Status screen.

Protecting/Unprotecting Messages

You can protect (save) up to 10 messages on the Br502. This prevents messages from being deleted or overwritten by new messages when the pager's memory is full.

- To protect a message, press the ● (Function) button while the message displays. When the word "PROTECT" appears press the ■ (Read/ Select) button to protect the message
- To unprotect a protected message, press the ● (Function) button while the protected message displays
- When the word "UNPROTECT" appears press the ■ (Read/ Select) button to unprotect the message

If at any time you wish to quit from the protect/unprotect message screen there are two methods for escaping: 1) Press both ■ + ● (Read/Select + Function) simultaneously to return to the message screen, 2) Wait for 15 seconds to return to the Status screen.

Deleting Messages

You can delete messages from your pager at any time. By deleting older messages, you decide which messages to keep and which to save before they are overwritten by new messages. (See also "Protecting/Unprotecting Messages" on page 20.)

Deleting an Individual Message

- To delete an unprotected message, press the ● (Function) button two times while the message is displayed
- *To delete a protected message, you must first unprotect the message. (See "Protecting/Unprotecting Messages" on page 20)
- Press the ■ (Read/ Select) button to confirm your decision
- To delete all messages see the instructions "Deleting All Messages" on page 11

If at any time you wish to quit from the delete message screen there are two methods for escaping; 1) Press both ■ + ● (Read/Select + Function) simultaneously to return to the message screen, 2) Wait for 15 seconds to return to the Status screen.

Br502 User Manual

DAVISCOMMS

DAVISCOMMS (S) PTE LTD
361 Ubi Road 3, #04-06
Armorcoat International Building
Singapore 408664

500028R02